**ADVANCED ERGONOMICS**
Maximum Comfort

XG251G

25" Display, IPS Panel, 1920 x 1080 Resolution

Satisfy your need for speed with the ViewSonic® XG251G. With a monstrous 360Hz refresh rate and a 1ms (GTG) response time, the ViewSonic XG251G takes your gameplay to new heights. See landscapes and battlefields in their full glory with a 25 inch display complete with a Full HD IPS panel and VESA DisplayHDR™ 400 technology. Featuring NVIDIA® Reflex and NVIDIA® G-Sync, the XG251G offers a low-latency gameplay experience that ruthlessly eliminates screen-tearing and stuttering to give you the edge you need to win the day.

OVERVIEW

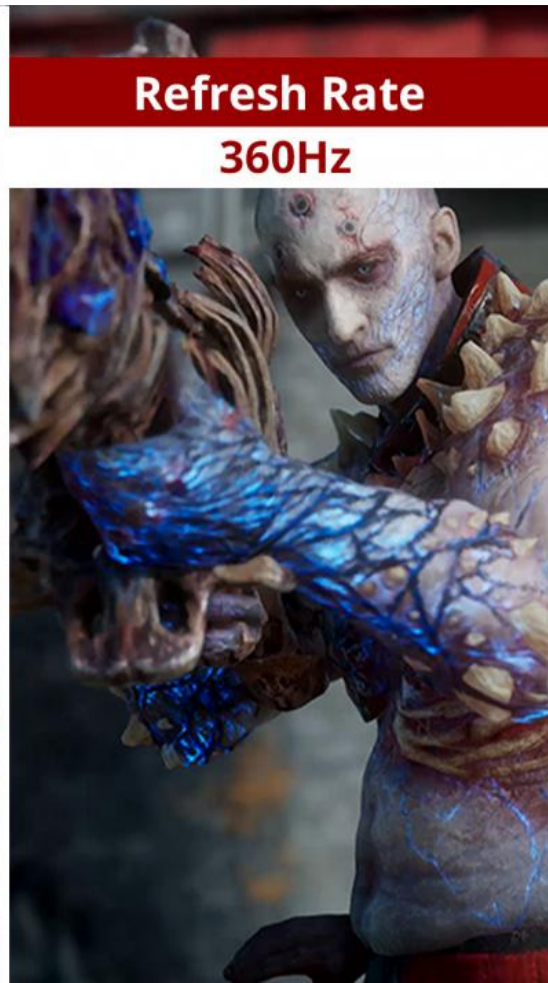
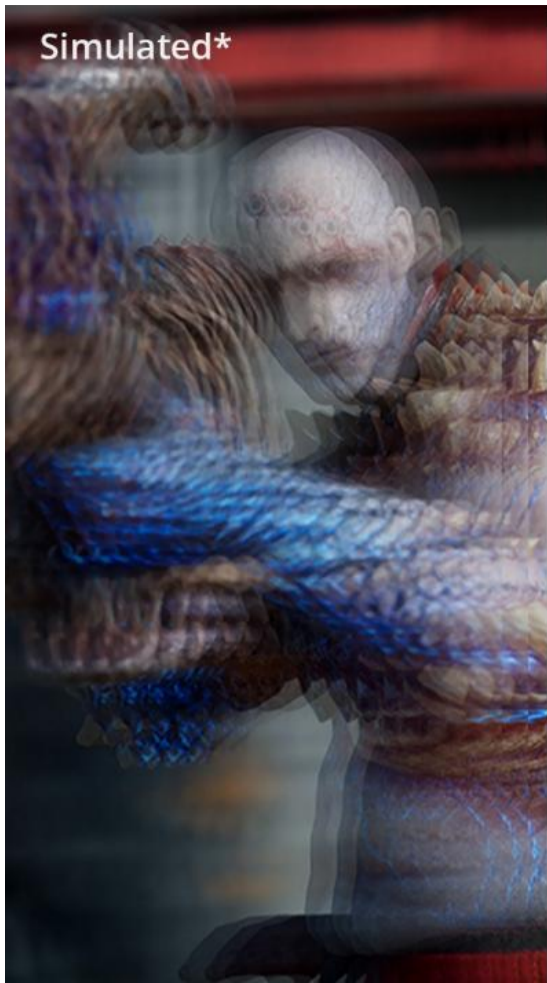

360HZ REFRESH RATE

Step into a new world of detail and visual fluidity with a 360Hz** refresh rate. No matter how frenetic the action is, this monitor keeps you one step ahead. Say goodbye to irritating tracers and motion blur and hello to a gaming experience like no other. **360Hz with DisplayPort (v1.4) and HDMI (v2.0) connection ports. *The image contained herein is simulated to reflect an image under different resolution (or scheme) for demonstration purposes only, and may not be the actual image displayed from the monitor.

NVIDIA G-SYNC™

NVIDIA® G-SYNC™ technology seamlessly synchronizes the frame rate output between your graphics card and monitor. This eliminates screen tearing, and minimizes stutter and input lag for a breathtaking gameplay experience.

*The image contained herein is simulated to reflect an image under different resolution (or scheme) for demonstration purposes only, and may not be the actual image displayed from the product.

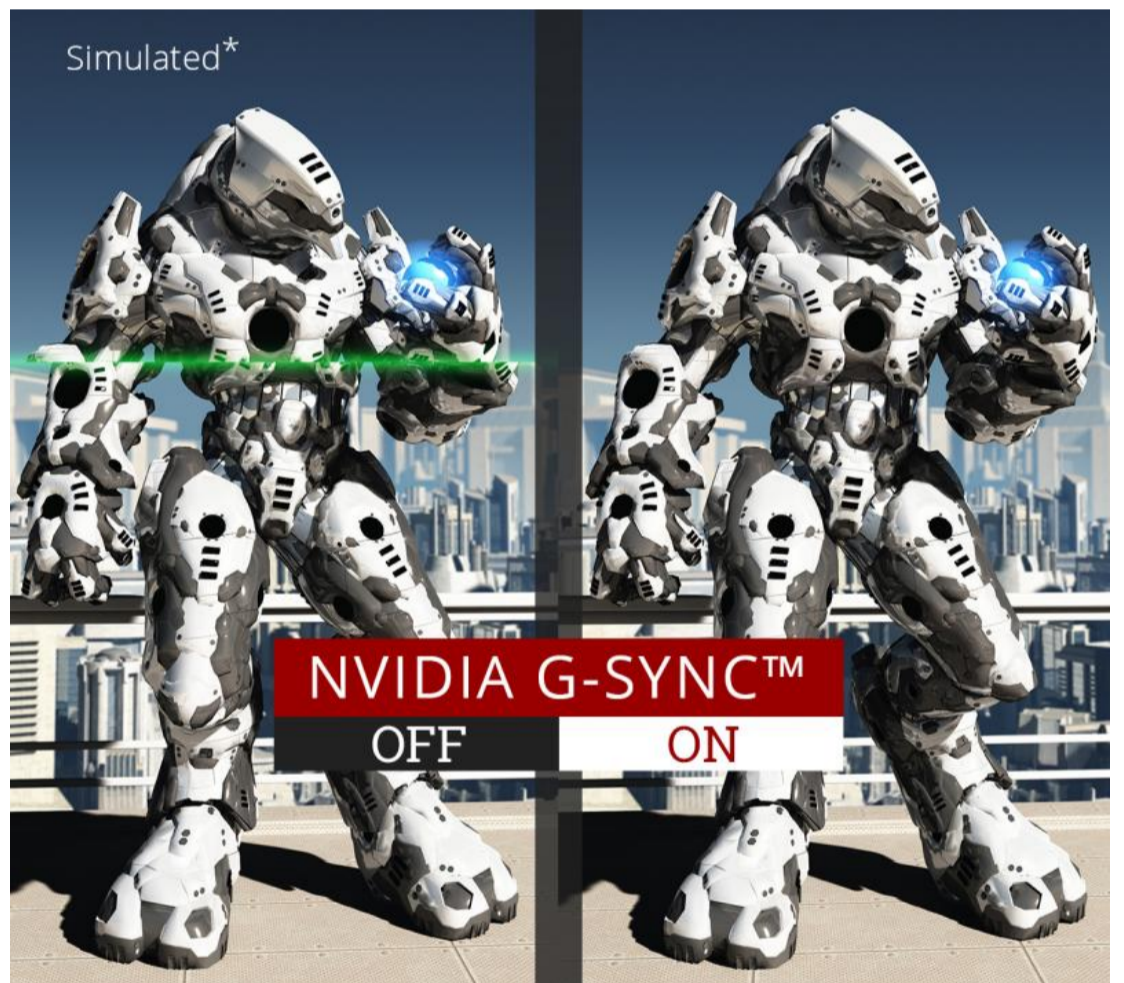

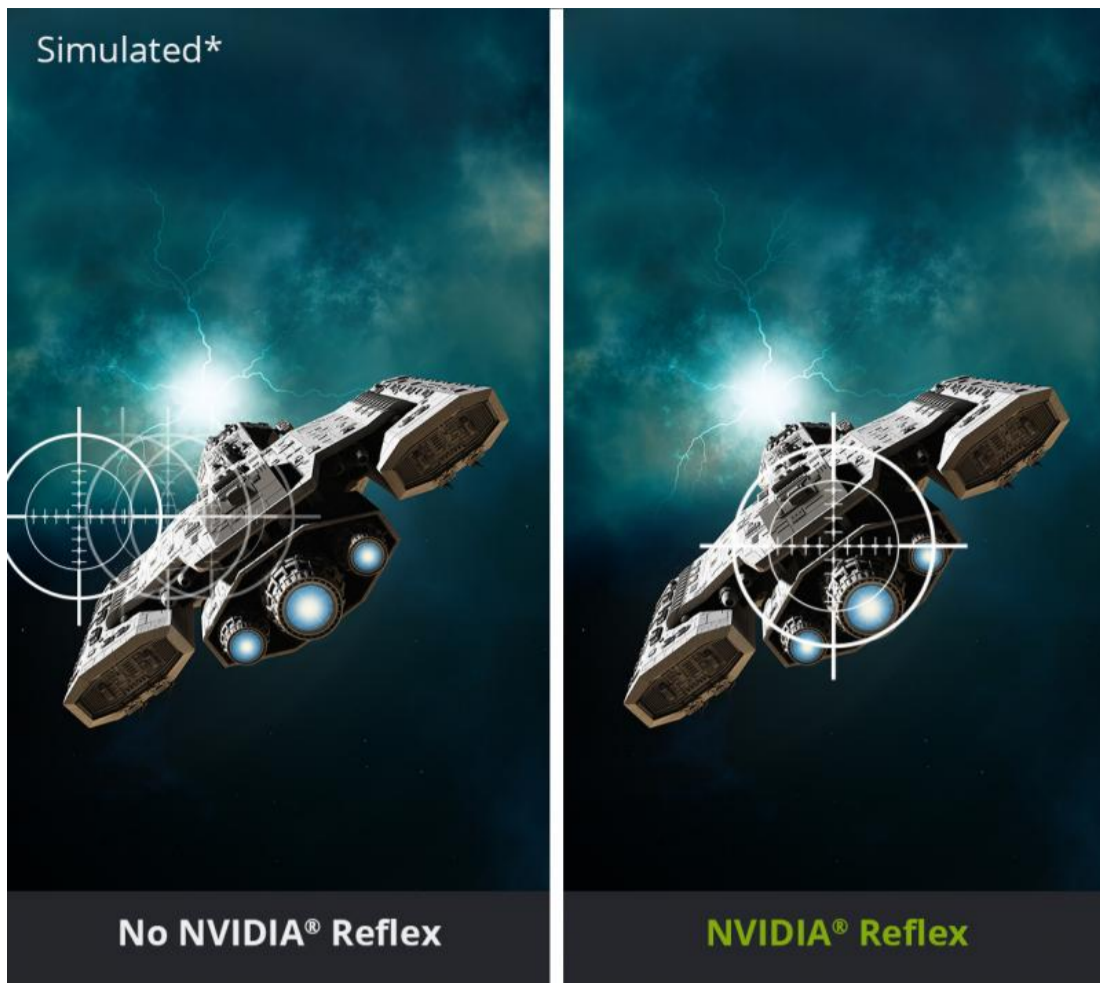

NVIDIA® REFLEX

Gain the edge in competitive gaming with NVIDIA® Reflex. With enhanced system optimizations that deliver the lowest possible latency, you can immerse yourself in a hyper-responsive gameplay experience that responds effortlessly to your commands.

1MS RESPONSE TIME

Aim with precision and react with lightning speed thanks to a 1ms (GTG) response time that delivers seamless pixel transitions and reduced ghosting.

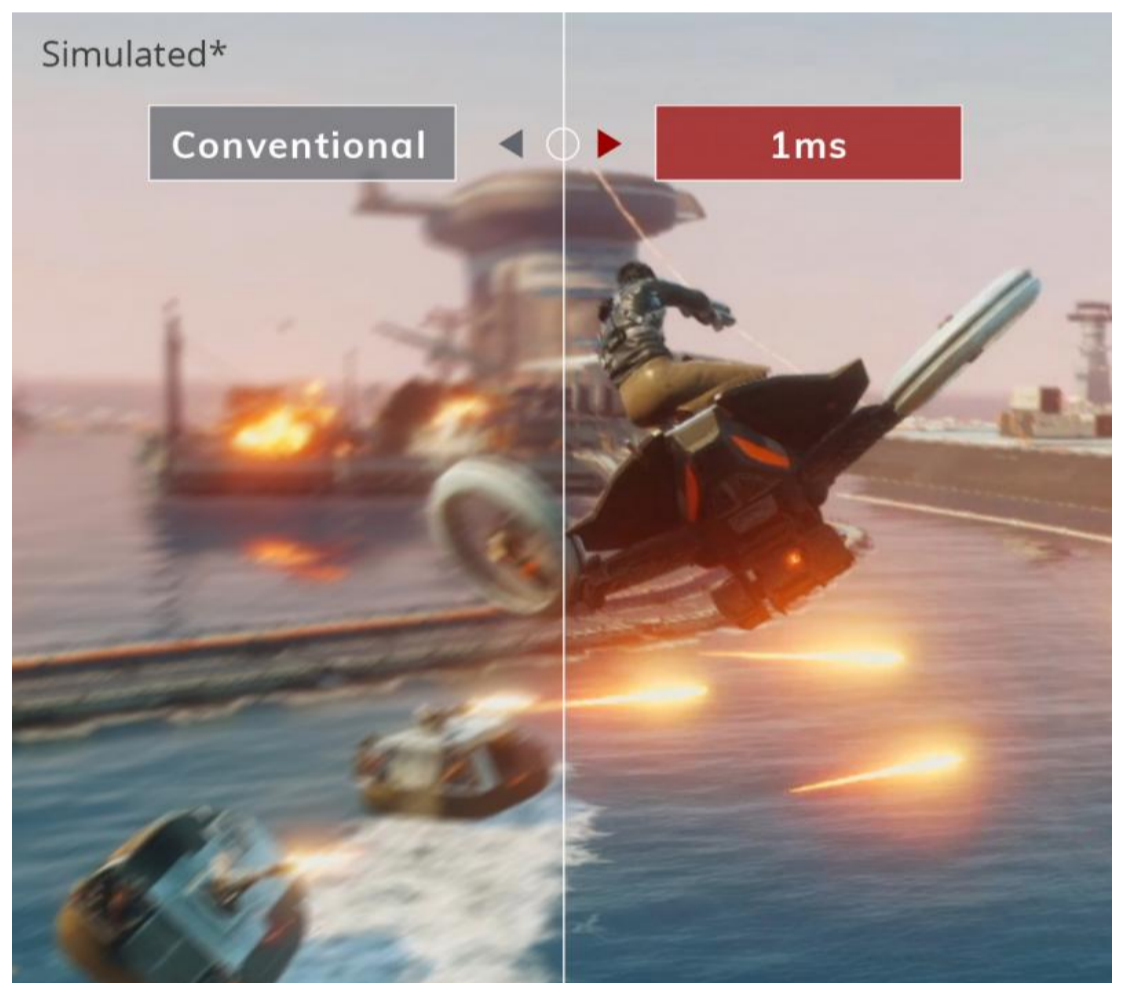

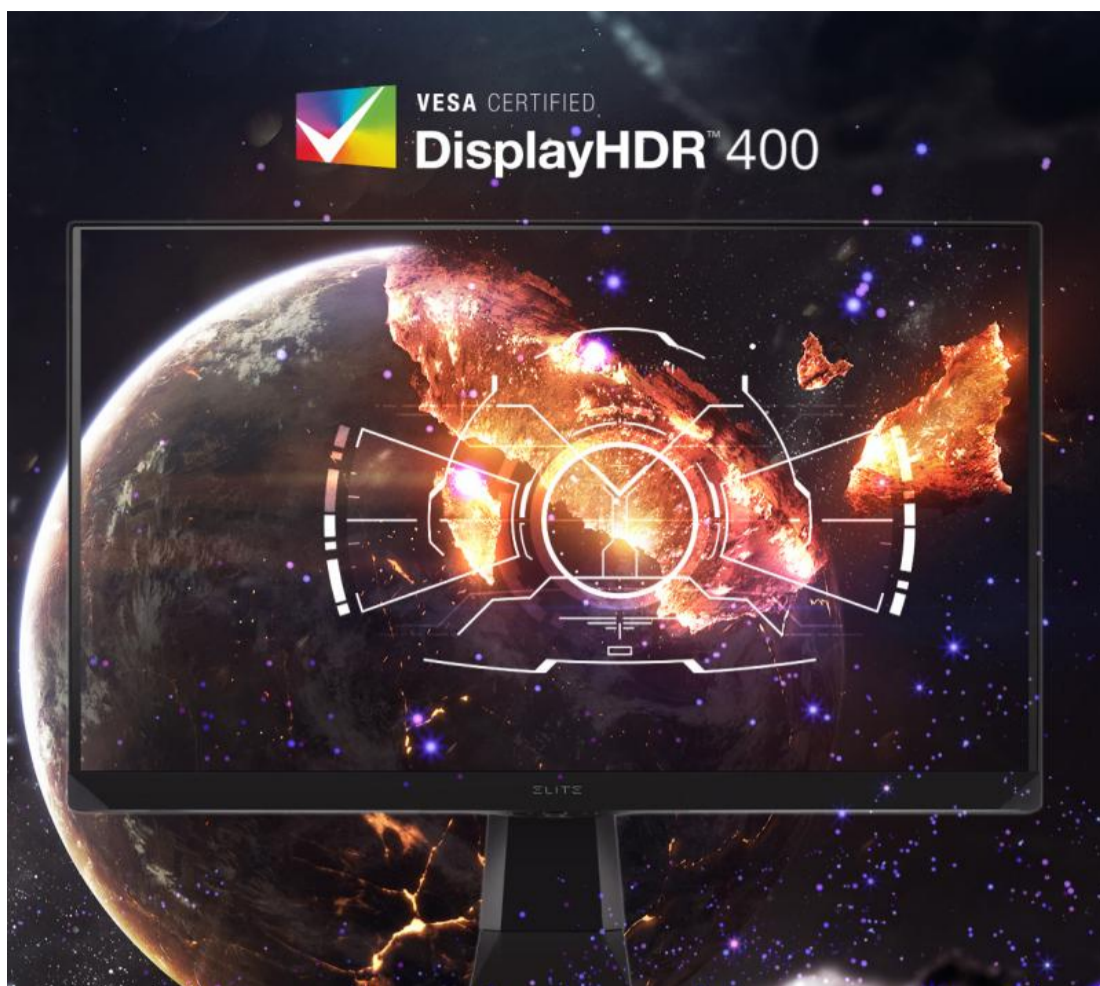

DISPLAYHDR™ 400

Immerse yourself in a new era of realism in gaming with a VESA-certified DisplayHDR™ 400 display. Enjoy optimal luminance, a powerful dynamic contrast ratio and breathtaking image quality.

FULL HD IPS DISPLAY

This stunning display is engineered to provide a better field of vision for esports and competitive play. View and easily access menus, maps, utilities and more with enhanced clarity.



WIDE COLOR COVERAGE

This monitor features both 99% sRGB coverage and 99% Adobe Coverage, providing creatives with incredible color accuracy across work for digital and print.

*Based on sRGB mode. Actual values may vary by 1% depending on color mode used.

3-YEAR LIMITED WARRANTY

Have peace of mind in the quality and reliability of your ViewSonic monitor—backed by one of the industry’s best pixel performance policies and a 3-year limited warranty.

SPECS

DISPLAY SIZE (IN.) 25	PANEL TYPE IPS	RESOLUTION 1920 x 1080	STATIC CONTRAST RATIO 1,000:1
---------------------------------	--------------------------	----------------------------------	---

DISPLAY		
DISPLAY SIZE (IN.) 25	VIEWABLE AREA (IN.) 24.5	PANEL TYPE IPS
RESOLUTION 1920 x 1080	RESOLUTION TYPE Full HD (1920x1080)	STATIC CONTRAST RATIO 1,000:1
DYNAMIC CONTRAST RATIO 120,000,000:1	LIGHT SOURCE LED	BRIGHTNESS 400 cd/m2
COLORS 16.7M	COLOR SPACE SUPPORT 8 bit true	ASPECT RATIO 16:9
RESPONSE TIME (GTG W/OD) 1.7ms	VIEWING ANGLES 178° horizontal, 178° vertical	BACKLIGHT LIFE (HOURS) 30,000
PANEL SURFACE Anti-glare, Hard coating (3H)	REFRESH RATE (HZ) 360	

COMPATIBILITY	
PC RESOLUTION (MAX) 1920x1080	MAC® RESOLUTION (MAX) 1920x1080

CONNECTOR		
USB TYPE A 3	USB TYPE B 1	3.5MM AUDIO OUT 1
HDMI 2.0 IN 2	DISPLAYPORT 1	

AUDIO	
INTERNAL SPEAKERS 2W (x2)	

POWER		
ECO MODE (CONSERVE) 24W	ECO MODE (OPTIMIZED) 27W	CONSUMPTION (TYPICAL) 30W
CONSUMPTION (MAX) 35W	VOLTAGE 100-240 VAC, 50-60Hz	STAND-BY 0.5W
POWER SUPPLY External		

CONTROLS	
PHYSICAL CONTROLS Joystick key: Up, Right, Down, Left, Center; Quick Access; Power	ON SCREEN DISPLAY Game Modes, Display, G-SYNC Processor, Input Select, Audio Adjust, Setup Menu

OPERATING CONDITIONS	
TEMPERATURE 32-104° F (0 - 40° C)	HUMIDITY (NON-CONDENSING) 20-90%

MOUNT	
VESA COMPATIBLE 100 x 100 mm	

VIDEO SIGNAL	
FREQUENCY HORIZONTAL HDMI (v2.0): 30 ~ 230KHz, DisplayPort (v1.4): 30 ~ 250KHz	FREQUENCY VERTICAL HDMI (v2.0): 48 ~ 360Hz, DisplayPort (v1.4): 48 ~ 360Hz

ERGONOMICS		
HEIGHT ADJUST 120 mm / 4.7 in	SWIVEL 60°	PIVOT (RIGHT/LEFT) 90° / 90°
TILT (FORWARD/BACK) 5° / 20°		

WEIGHT (IMPERIAL)		
NET (LBS)	NET WITHOUT STAND (LBS)	GROSS (LBS)
13.4	7.9	22.5

WEIGHT (METRIC)		
NET (KG)	NET WITHOUT STAND (KG)	GROSS (KG)
6.1	3.6	10.2

DIMENSIONS (IMPERIAL) (WXHxD)		
PACKAGING (IN.)	PHYSICAL (IN.)	PHYSICAL WITHOUT STAND (IN.)
25.7 x 19.7 x 10.4	22 x 15.9~20.6 x 9.8	22 x 14 x 2.6

DIMENSIONS (METRIC) (WXHxD)		
PACKAGING (MM)	PHYSICAL (MM)	PHYSICAL WITHOUT STAND (MM)
653.0 x 500.0 x 265.0	558.0 x 402.7~522.7 x 248.0	558.0 x 355.0 x 67.0

GENERAL		
REGULATIONS cTUVus, FCC-B, ICES003, CEC, NRCAN, NOM, Mexico Energy, CE, CE EMC, CB, RoHS, ErP, REACH, WEEE, EAC, UkrSEPRO, UKCA, BSMI, RCM, GEMS, CCC, China RoHS, China Energy Label	PACKAGE CONTENTS XG251G, 3-pin Mickey Mouse Plug (IEC C5), DisplayPort Cable (v1.2; Male-Male), USB A/B Cable (v3.2; Male-Male), AC/DC Adapter, Quick Start Guide	RECYCLE/DISPOSAL Please dispose of in accordance with local, state or federal laws.
WARRANTY Three-year limited warranty on parts, labor and backlight		

DIMENSIONS

22 x 15.9~20.6 x 9.8 in / 558.0 x 402.7~522.7 x 248.0 mm

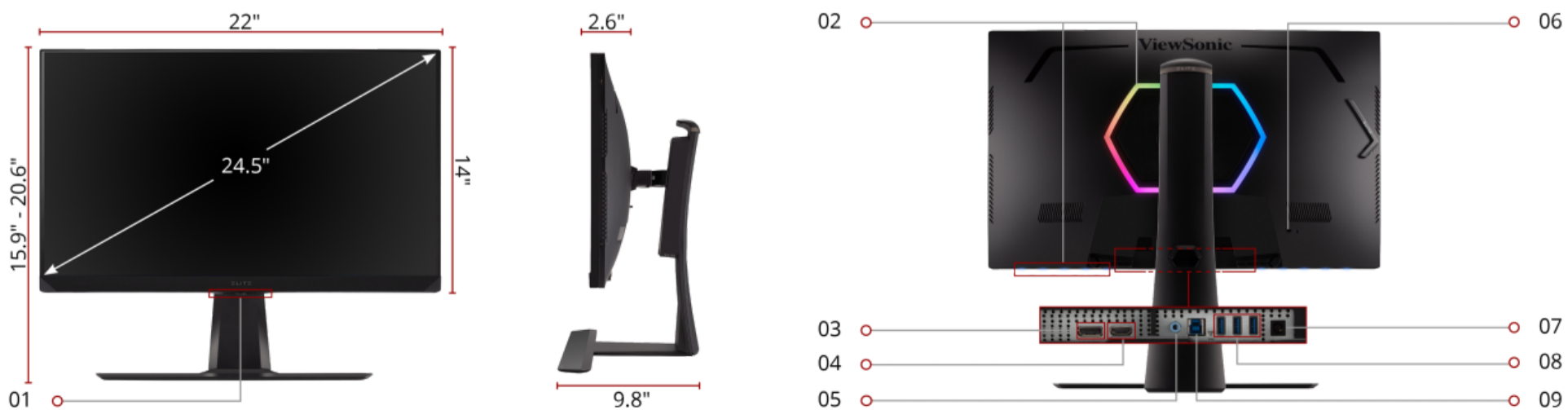

1. Menu Controls 2. ViewSonic ELITETM RGB 3. DisplayPort In
 4. HDMI 2.0 5. Audio Out 6. Kensington Lock Slot 7. DC Power In

8. USB 3.2 Type-A (x2) 9. USB 3.2 Type-B

[Privacy Policy](#) [Terms of use](#)

Programs, specifications, pricing and availability are subject to change without notice. Selections, offers and programs may vary by country; see your ViewSonic representative for complete details. Copyright © ViewSonic Corporation 2000-2022. All rights reserved.